

**SURVEY PLAN CERTIFICATION  
PROVINCE OF BRITISH COLUMBIA**

PAGE 1 OF 18 PAGES

Your electronic signature is a representation that you are a British Columbia land surveyor and a subscriber under section 168.6 of the *Land Title Act*, RSBC 1996 c.250. By electronically signing this document, you are also electronically signing the attached plan under section 168.3 of the act.

**Jennifer Ashton  
KEM896**

Digitally signed by  
Jennifer Ashton KEM896  
Date: 2024.07.29  
15:51:17 -07'00'

1. BC LAND SURVEYOR: (Name, address, phone number)

Jennifer Ashton, BCLS

Runnalls Denby Land Surveying Ltd.

259A Lawrence Avenue

Kelowna

BC V1Y 6L2

jen@runnallsdenby.com

250-763-7622

File: 16488

Surveyor General Certification [For Surveyor General Use Only]

2. PLAN IDENTIFICATION:

Control Number: **172-229-3478**

Plan Number: **EPS9966**

This original plan number assignment was done under Commission #: **984**

3. CERTIFICATION:

Form 9     Explanatory Plan     Form 9A

I am a British Columbia land surveyor and certify that I was present at and personally superintended this survey and that the survey and plan are correct.

The field survey was completed on: 2024 July 25 (YYYY/Month/DD)    The checklist was filed under ECR#: 284073  
The plan was completed and checked on: 2024 July 29 (YYYY/Month/DD)

I am a British Columbia land surveyor and certify that the buildings included in this strata plan have not been previously occupied as of 2024 July 25 (YYYY/Month/DD)  None  Strata Form S

None  Strata Form U1  Strata Form U1/U2

I am a British Columbia land surveyor and certify that the buildings shown on this strata plan are within the external boundaries of the land that is the subject of the strata plan

Certification Date: 2024 July 29 (YYYY/Month/DD)

Arterial Highway

Remainder Parcel (Airspace)

4. ALTERATION:

**STRATA PLAN OF PART OF LOT 3 SECTION 31 TOWNSHIP 26  
OSOYOOS DIVISION YALE DISTRICT PLAN EPP100150  
EXCEPT STRATA PLAN EPS9966 (PHASE 1)**

**STRATA PLAN EPS9966  
PHASE 2**

BCGS 82E.0B3



The intended plot size of this plan is 432mm in width by 280mm in height (B size) when plotted at a scale of 1:600  
( All distances are in metres )

1455 Cara Glen Court,  
Kelowna, B.C.

**LEGEND**

- Denotes Standard Iron post (Type 5) found
- Denotes Standard Iron post (Type 5) placed
- ⊙ Denotes Control Monument found
- Reset Denotes IP previously tied February 6, 2020  
(See Plan EPP100150) lost and replaced using ties from the original control traverse.

73H1793  
UTM Zone 11 coordinates  
Datum: NAD83(CSRG) 4.0.0.BC.1  
UTM northing: 5531148.644  
UTM easting: 323074.222  
Estimated Absolute Accuracy  
Achieved: 0.02m.

74H2435  
UTM Zone 11 coordinates  
Datum: NAD83(CSRG) 4.0.0.BC.1  
UTM northing: 5530188.896  
UTM easting: 323085.815  
Estimated Absolute Accuracy  
Achieved: 0.02m.

Integrated Survey Area No. 4, City of Kelowna,  
NAD83 (CSRS) 4.0.0.BC.1

Grid bearings are derived from GNSS observations and are referred to the central meridian of UTM Zone 11.

The UTM coordinates and estimated absolute accuracies achieved are derived from survey ties to geodetic control monuments 73H1793 and 74H2435.

This plan shows horizontal ground-level distances unless otherwise specified. To compute grid distances, multiply ground-level distances by the combined factor of 0.9999168 which has been derived from geodetic control monument 73H1793.

Measurements to exterior foundation on this sheet.

Offsets to property lines are perpendicular thereto and are measured to the exterior face of building foundation wall.

This Plan is Phase 2 of a 3 phase strata plan under section 224 of the Strata Property Act lying within the jurisdiction of the Approving Officer for the City of Kelowna.

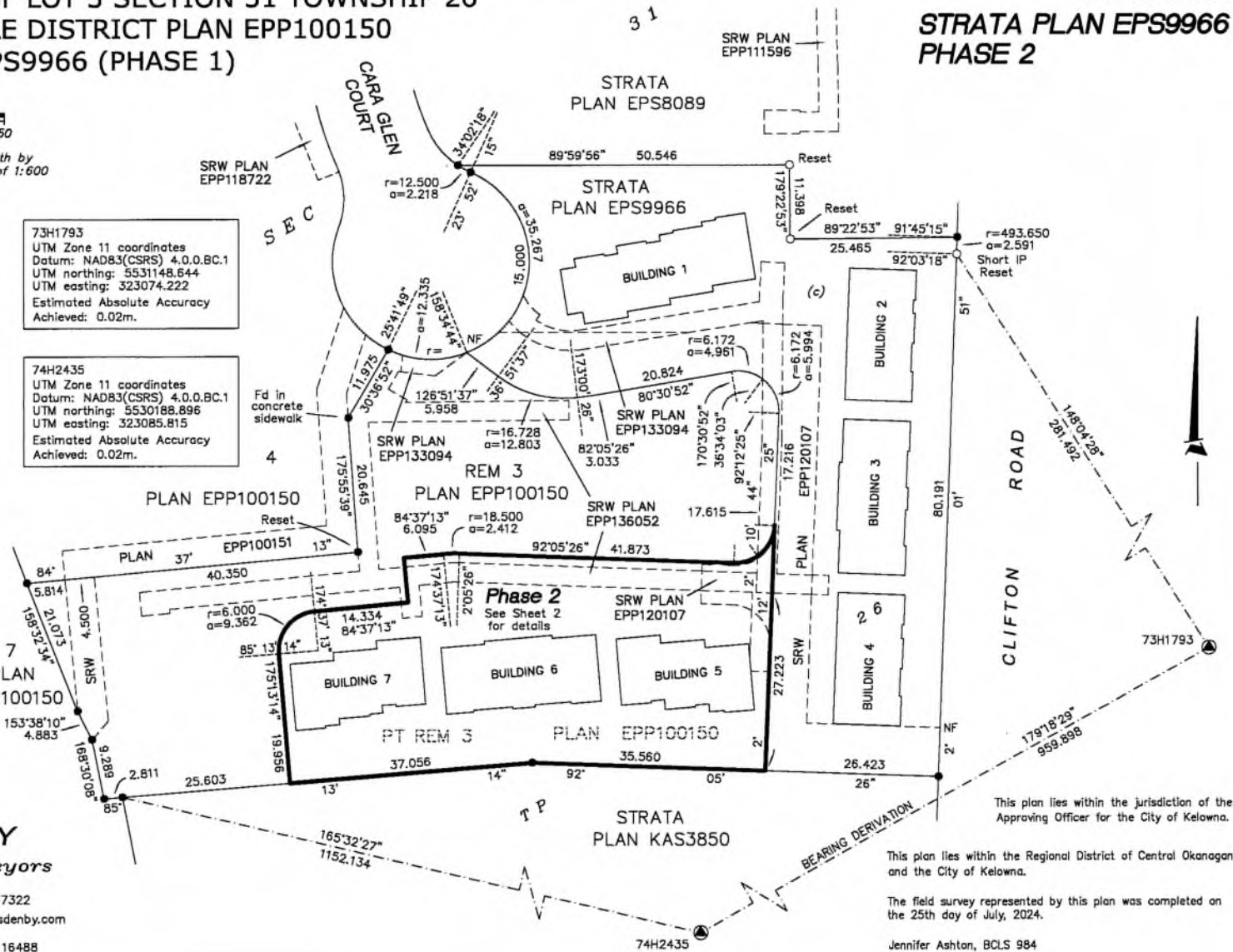

**RUNNALLS DENBY**

british columbia land surveyors

259A Lawrence Avenue  
Kelowna, B.C.  
V1Y 6L2

Phone: (250)763-7322  
Email: jen@runnallsdenby.com

DWG. No.: 16488 Strata Ph 2

FILE: 16488

This plan lies within the jurisdiction of the Approving Officer for the City of Kelowna.

This plan lies within the Regional District of Central Okanagan and the City of Kelowna.

The field survey represented by this plan was completed on the 25th day of July, 2024.

Jennifer Ashton, BCLS 984

# BUILDINGS 5 TO 7 FOUNDATIONS

SHEET 2 OF 17 SHEETS

## STRATA PLAN EPS9966 PHASE 2



The intended plot size of this plan is 432mm in width by 279mm in height (B size) when plotted at a scale of 1:400  
( All distances are in metres )

Offsets to property lines are perpendicular thereto and are measured to the exterior face of building foundation wall.

All angles defect by multiples of 45 or 90 degrees unless otherwise indicated.

All patios, decks, driveways and terraces are limited in height by the centerline of the floor/ceiling above or its extension.

The buildings in this strata plan have not been previously occupied.

The buildings shown hereon are within the external defined boundaries of the land that is the subject of the strata plan.

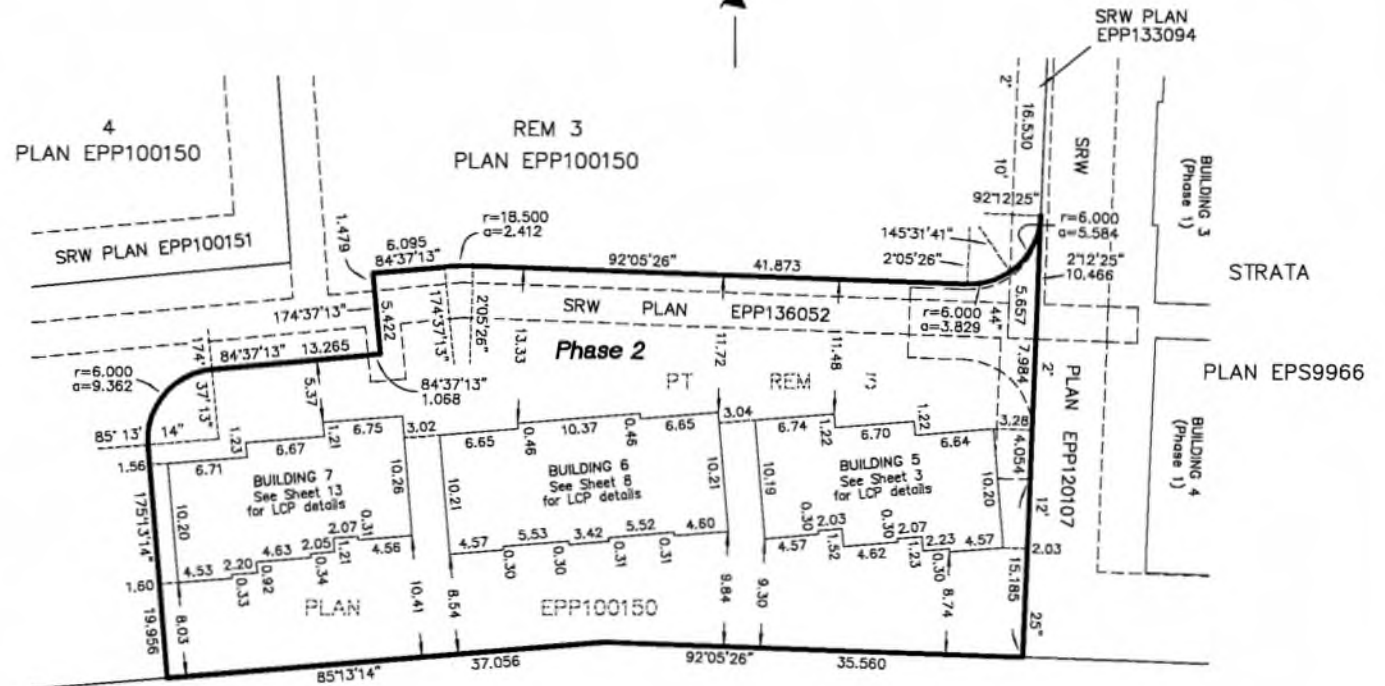

STRATA  
PLAN KAS3850

**RUNNALLS DENBY**  
british columbia land surveyors

259A Lawrence Avenue  
Kelowna, B.C.  
V1Y 8L2  
Phone: (250)763-7322  
Email: jen@runnallsdenby.com

DWG. No.: 16488 Strata Ph 2 FILE: 16488

Jennifer Ashton, BCLS 984  
July 25, 2024

# BUILDING 5 LEVEL 1

# STRATA PLAN EPS9966 PHASE 2



The intended plot size of this plan is 432mm in width by 280mm in height (B size) when plotted at a scale of 1:125  
( All distances are in metres )

**LEGEND**

- SL Denotes Strata Lot
- NH Denotes Non-Habitable
- LCP Denotes Limited Common Property
- PT Denotes Part of Strata Lot

This sheet shows strata boundary dimensions to the midpoint of the structural portion of the exterior walls and the midpoint between structural portions of party walls between strata lots.

All LCP Patios, Decks, Driveways and Terraces are limited in height by the center of the floor above, or its extensions, or where there is no floor above, by the average height of a Strata Lot in the same building, unless otherwise indicated.

Cross section arrows on this plan point in the direction of view.

This sheet does not include any grid bearings, non-tangential deflections are noted as angles in degrees and minutes.

Strata lot boundary midpoint of structural portion of party wall between strata lots (typ)

LCP boundary midpoint of structural portion of exterior wall (typ)

Strata lot boundary midpoint of structural portion of exterior walls (typ)

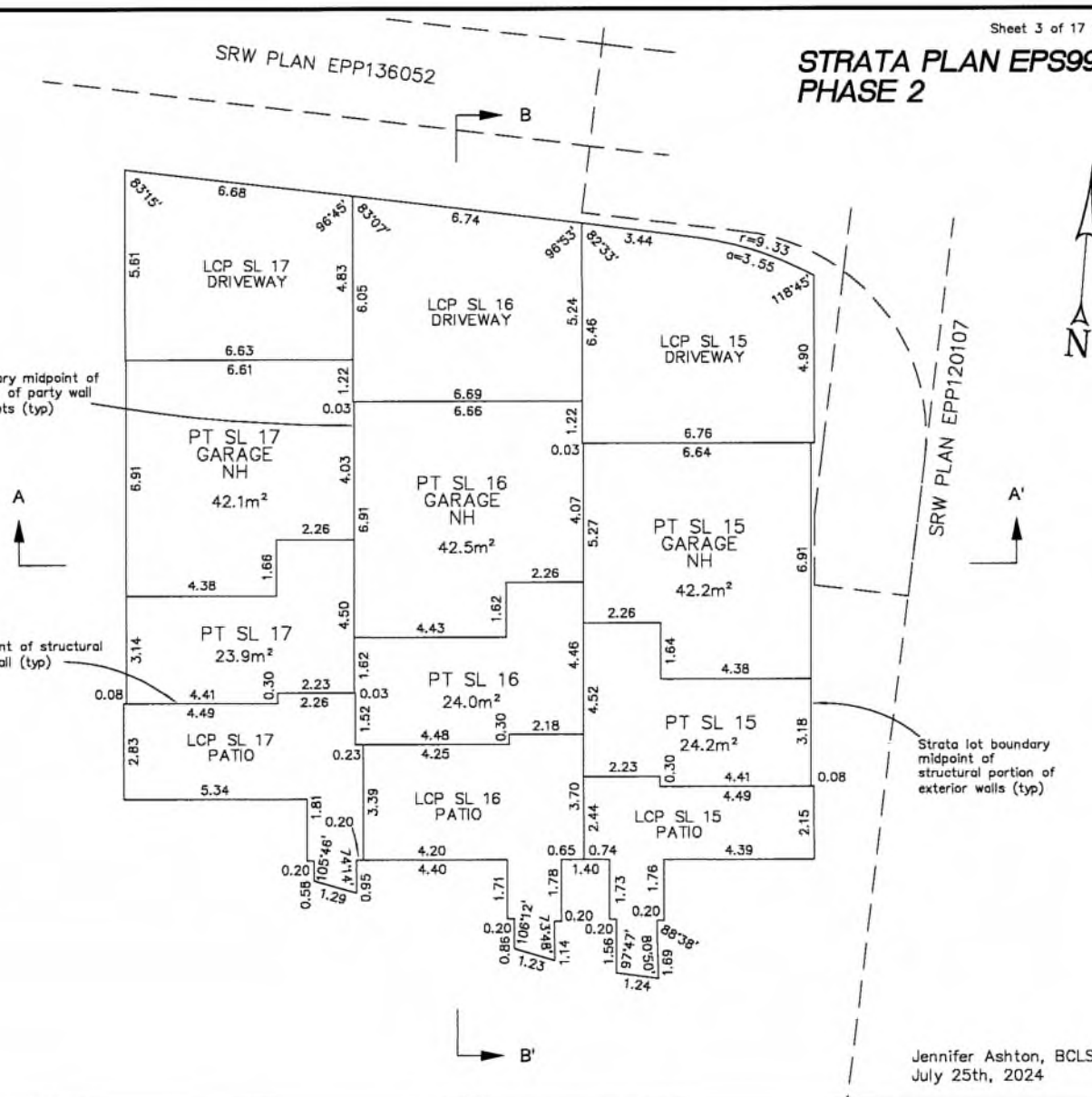

**RUNNALLS DENBY**

british columbia land surveyors

259A Lawrence Avenue Kelowna, B.C. V1Y 6L2  
Phone: (250)763-7322  
Email: jen@runnallsdenby.com

# BUILDING 5 LEVEL 2

# STRATA PLAN EPS9966 PHASE 2



The intended plot size of this plan is 432mm in width by 280mm in height (B size) when plotted at a scale of 1:125  
( All distances are in metres )

**LEGEND**

- SL Denotes Strata Lot
- PT Denotes Part of Strata Lot
- PFB Denotes Perimeter of Floor Below

This sheet shows strata boundary dimensions to the midpoint of the structural portion of the exterior walls and the midpoint between structural portions of party walls between strata lots.

Cross section arrows on this plan point in the direction of view.

All LCP Patios, Decks, Driveways and Terraces are limited in height by the center of the floor above, or its extensions, or where there is no floor above, by the average height of a Strata Lot in the same building, unless otherwise indicated.

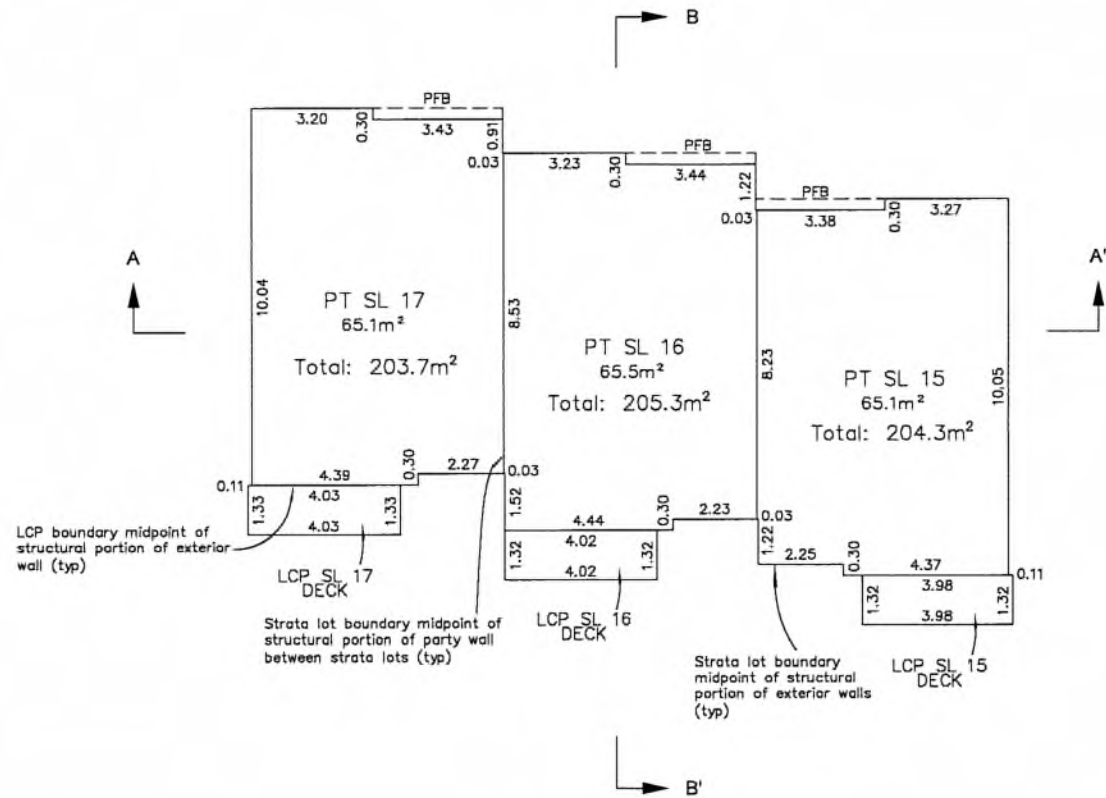

**RUNNALLS DENBY**

british columbia land surveyors

259A Lawrence Avenue Kelowna, B.C. V1Y 6L2  
Phone: (250)763-7322 Email: jen@runnallsdenby.com

# BUILDING 5 LEVEL 3

Sheet 5 of 17 Sheets

## STRATA PLAN EPS9966 PHASE 2



The intended plot size of this plan is 432mm in width by 280mm in height (B size) when plotted at a scale of 1:125  
( All distances are in metres )

**LEGEND**

SL Denotes Strata Lot  
PT Denotes Part of Strata Lot

This sheet shows strata boundary dimensions to the midpoint of the structural portion of the exterior walls and the midpoint between structural portions of party walls between strata lots.

Cross section arrows on this plan point in the direction of view.

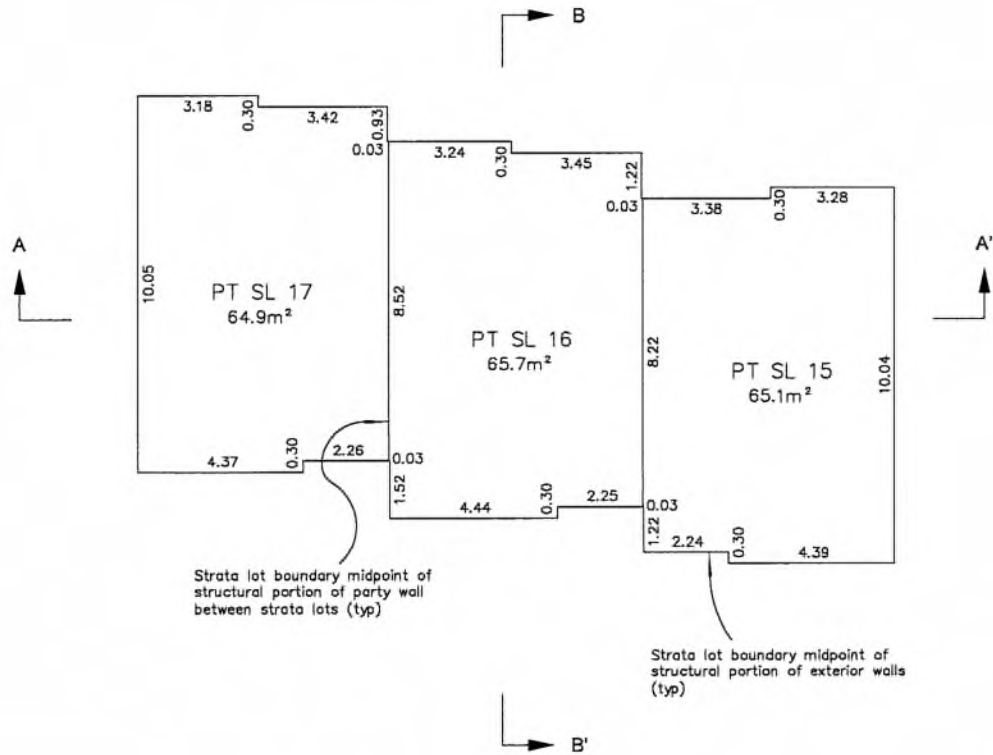

**RUNNALLS DENBY**

british columbia land surveyors

259A Lawrence Avenue Kelowna, B.C. V1Y 6L2  
Phone: (250)763-7322  
Email: jen@runnallsdenby.com

DWG. No.: 16488 Strata

FILE: 16488

Jennifer Ashton, BCLS 984  
July 25th, 2024

# BUILDING 5 LEVEL 4

## STRATA PLAN EPS9966 PHASE 2



The intended plot size of this plan is 432mm in width by 280mm in height (B size) when plotted at a scale of 1:125

( All distances are in metres )

### LEGEND

- SL Denotes Strata Lot
- LCP Denotes Limited Common Property
- PT Denotes Part of Strata Lot
- PFB Denotes Perimeter of Floor Below
- (c) Denotes Common Property

This sheet shows strata boundary dimensions to the midpoint of the structural portion of the exterior walls and the midpoint between structural portions of party walls between strata lots.

All LCP Patios, Decks, Driveways and Terraces are limited in height by the center of the floor above, or its extensions, or where there is no floor above, by the average height of a Strata Lot in the same building, unless otherwise indicated.

Cross section arrows on this plan point in the direction of view.

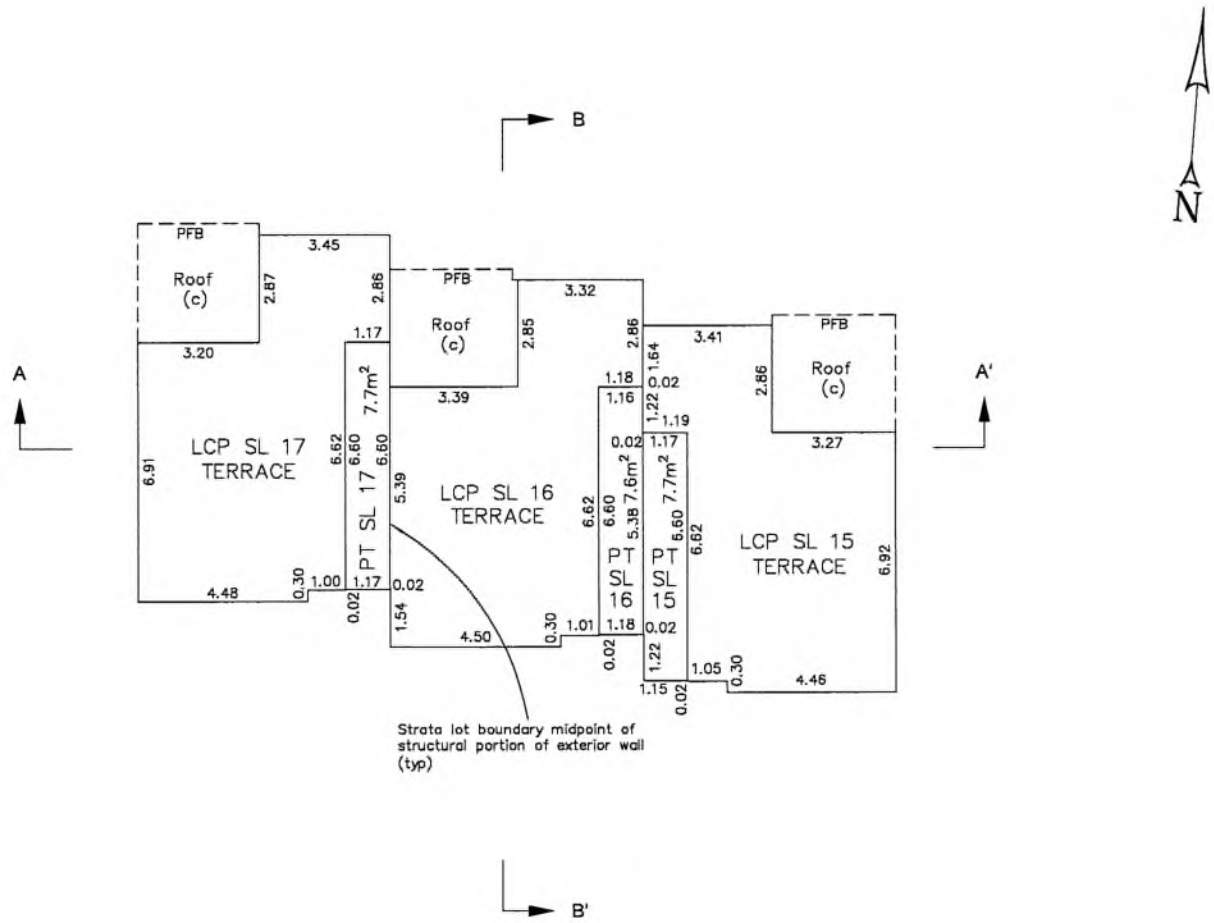

### RUNNALLS DENBY

british columbia land surveyors

259A Lawrence Avenue  
Kelowna, B.C.  
V1Y 6L2  
Phone: (250)763-7322  
Email: jen@runnallsdenby.com

# BUILDING 5 CROSS SECTIONS

## STRATA PLAN EPS9966 PHASE 2



The intended plot size of this plan is 432mm in width by 280mm in height (B size) when plotted at a scale of 1:150  
(All distances are in metres)

**LEGEND**

- SL Denotes Strata Lot
- LCP Denotes Limited Common Property
- PT Denotes Part of Strata Lot
- NH Denotes Non-Habitable
- (c) Denotes Common Property

This sheet shows strata boundary dimensions to the midpoint of the structural portion of the exterior walls and the midpoint between structural portions of party walls between strata lots.

All LCP Patios, Decks, Driveways and Terraces are limited in height by the center of the floor above, or its extensions, or where there is no floor above, by the average height of a Strata Lot in the same building, unless otherwise indicated.

### CROSS SECTION A-A'

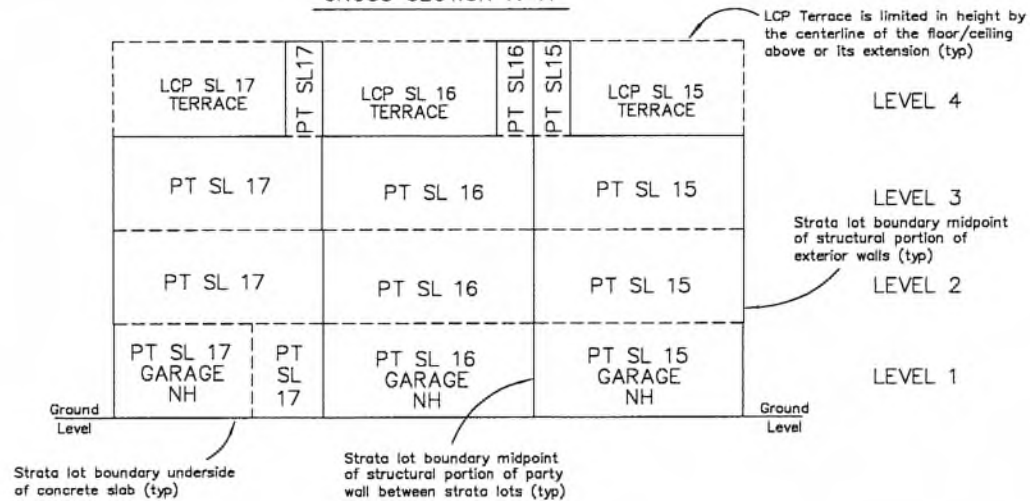

### CROSS SECTION B-B'

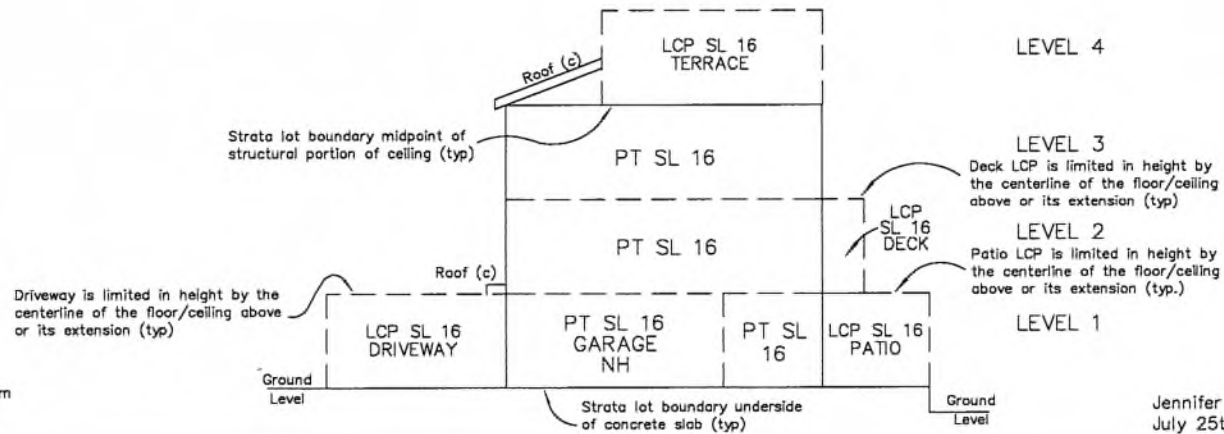

**RUNNALLS DENBY**

british columbia land surveyors

259A Lawrence Avenue  
Kelowna, B.C.  
V1Y 6L2

Phone: (250)763-7322  
Email: [jen@runnallsdenby.com](mailto:jen@runnallsdenby.com)



# BUILDING 6 LEVEL 1

Sheet 8 of 17 Sheets

## STRATA PLAN EPS9966 PHASE 2



The intended plot size of this plan is 432mm in width by 280mm in height (B size) when plotted at a scale of 1:150  
(All distances are in metres)

### LEGEND

SL Denotes Strata Lot  
LCP Denotes Limited Common Property  
PT Denotes Part of Strata Lot

This sheet shows strata boundary dimensions to the midpoint of the structural portion of the exterior walls and the midpoint between structural portions of party walls between strata lots.

Cross section arrows on this plan point in the direction of view.

All LCP Patios, Decks, Driveways and Terraces are limited in height by the center of the floor above, or its extensions, or where there is no floor above, by the average height of a Strata Lot in the same building, unless otherwise indicated.

This sheet does not include any grid bearings, non-tangential deflections are noted as angles in degrees and minutes.

Strata lot boundary midpoint of structural portion of exterior walls (typ)

LCP boundary midpoint of structural portion of exterior wall (typ)

Strata lot boundary midpoint of structural portion of party wall between strata lots (typ)

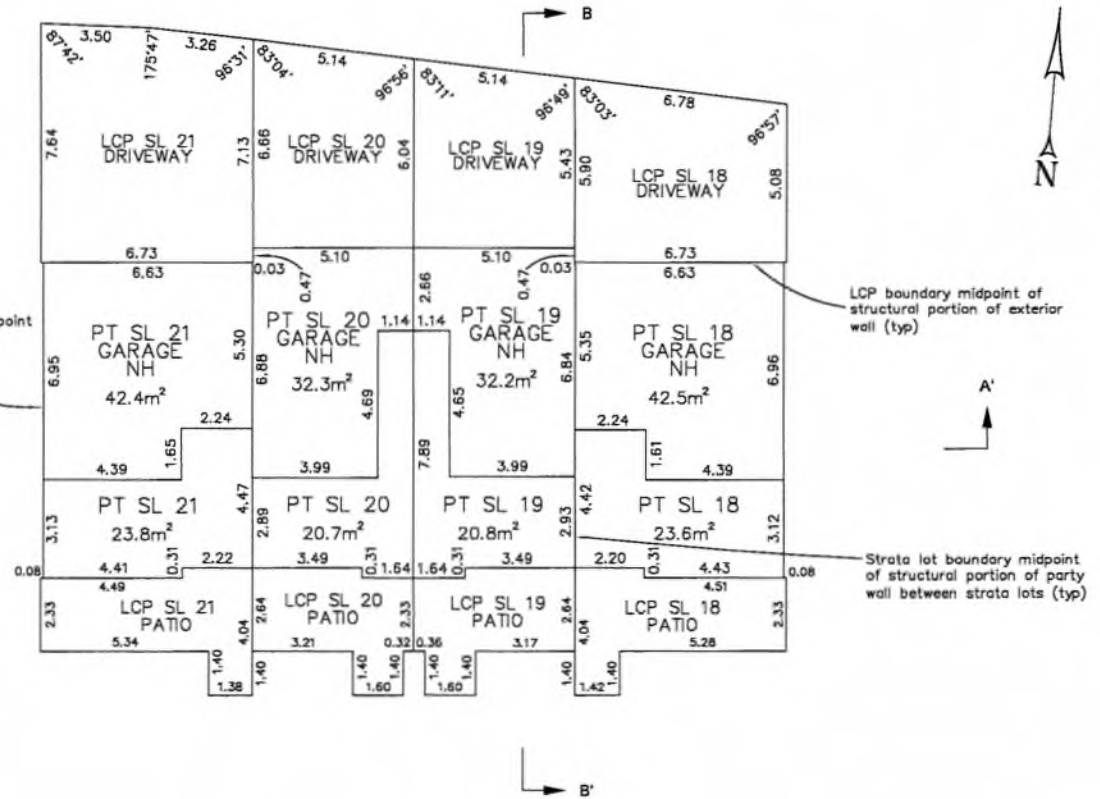

### RUNNALLS DENBY

british columbia land surveyors

259A Lawrence Avenue Kelowna, B.C. V1Y 6L2  
Phone: (250)763-7322  
Email: jen@runnallsdenby.com

DWG. No.: 16488 Strata

FILE: 16488

Jennifer Ashton, BCLS 984  
July 25th, 2024

# BUILDING 6 LEVEL 2

Sheet 9 of 17 Sheets

## STRATA PLAN EPS9966 PHASE 2



The intended plot size of this plan is 432mm in width by 280mm in height (B size) when plotted at a scale of 1:150  
(All distances are in metres)

### LEGEND

- SL Denotes Strata Lot
- LCP Denotes Limited Common Property
- PT Denotes Part of Strata Lot
- PFB Denotes Perimeter of Floor Below

This sheet shows strata boundary dimensions to the midpoint of the structural portion of the exterior walls and the midpoint between structural portions of party walls between strata lots.

Cross section arrows on this plan point in the direction of view.

All LCP Patios, Decks, Driveways and Terraces are limited in height by the center of the floor above, or its extensions, or where there is no floor above, by the average height of a Strata Lot in the same building, unless otherwise indicated.

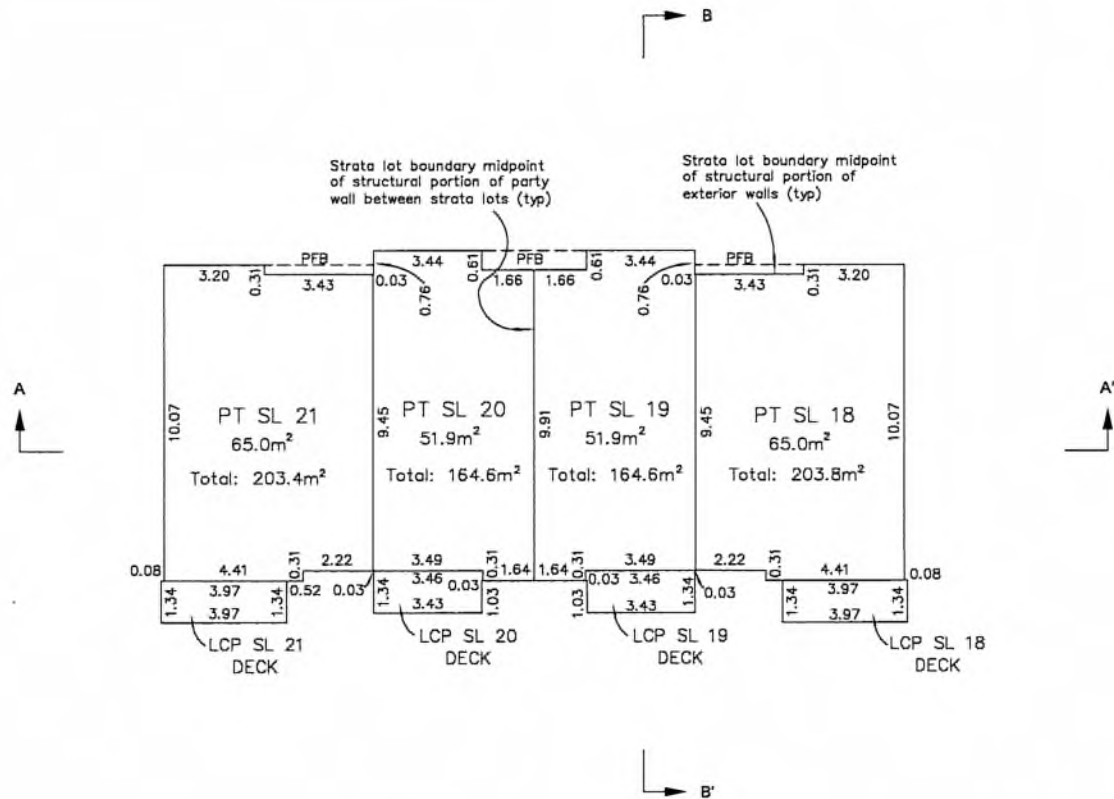

### RUNNALLS DENBY

british columbia land surveyors

259A Lawrence Avenue  
Kelowna, B.C.  
V1Y 6L2  
Phone: (250)763-7322  
Email: jen@runnallsdenby.com

DWG. No.: 16488 Strata

FILE: 16488

Jennifer Ashton, BCLS 984  
July 25th, 2024

# BUILDING 6 LEVEL 3

## STRATA PLAN EPS9966 PHASE 2



The intended plot size of this plan is 432mm in width by 280mm in height (B size) when plotted at a scale of 1:150  
(All distances are in metres)

### LEGEND

- SL Denotes Strata Lot
- LCP Denotes Limited Common Property
- PT Denotes Part of Strata Lot

This sheet shows strata boundary dimensions to the midpoint of the structural portion of the exterior walls and the midpoint between structural portions of party walls between strata lots.

Cross section arrows on this plan point in the direction of view.

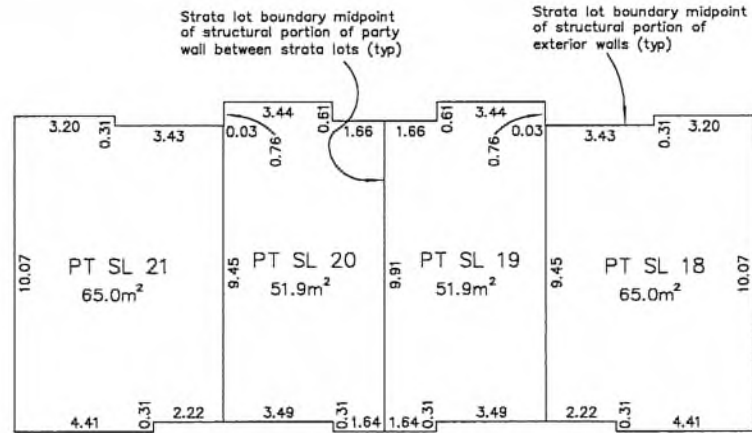

### RUNNALLS DENBY

british columbia land surveyors

259A Lawrence Avenue  
Kelowna, B.C.  
V1Y 6L2

Phone: (250)763-7322  
Email: jen@runnallsdenby.com

DWG. No.: 16488 Strata FILE: 16488

Jennifer Ashton, BCLS 984  
July 25th, 2024

# BUILDING 6 LEVEL 4

Sheet 11 of 17 Sheets

## STRATA PLAN EPS9966 PHASE 2



The intended plot size of this plan is 432mm in width by 280mm in height (B size) when plotted at a scale of 1:150  
(All distances are in metres)

### LEGEND

- SL Denotes Strata Lot
- LCP Denotes Limited Common Property
- PT Denotes Part of Strata Lot
- PFB Denotes Perimeter of Floor Below
- (c) Denotes Common Property

This sheet shows strata boundary dimensions to the midpoint of the structural portion of the exterior walls and the midpoint between structural portions of party walls between strata lots.

Cross section arrows on this plan point in the direction of view.

All LCP Patios, Decks, Driveways and Terraces are limited in height by the center of the floor above, or its extensions, or where there is no floor above, by the average height of a Strata Lot in the same building, unless otherwise indicated.



Strata lot boundary midpoint of structural portion of exterior wall (typ)



### RUNNALLS DENBY

british columbia land surveyors

259A Lawrence Avenue  
Kelowna, B.C.  
V1Y 6L2

Phone: (250)763-7322  
Email: jen@runnallsdenby.com

DWG. No.: 16488 Strata

FILE: 16488

Jennifer Ashton, BCLS 984  
July 25th, 2024

# BUILDING 6 CROSS SECTIONS

## STRATA PLAN EPS9966 PHASE 2



The intended plot size of this plan is 432mm in width by 280mm in height (B size) when plotted at a scale of 1:150  
(All distances are in metres)

**LEGEND**

- SL Denotes Strata Lot
- LCP Denotes Limited Common Property
- PT Denotes Part of Strata Lot
- NH Denotes Non-Habitable

This sheet shows strata boundary dimensions to the midpoint of the structural portion of the exterior walls and the midpoint between structural portions of party walls between strata lots.

All LCP Patios, Decks, Driveways and Terraces are limited in height by the center of the floor above, or its extensions, or where there is no floor above, by the average height of a Strata Lot in the same building, unless otherwise indicated.

### CROSS SECTION A-A'

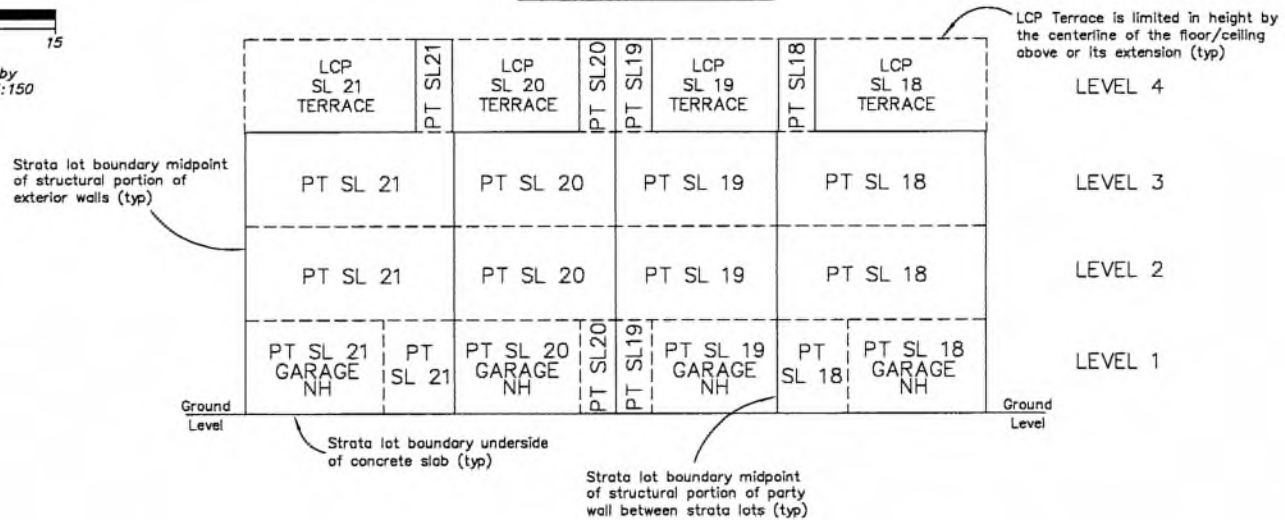

### CROSS SECTION B-B'

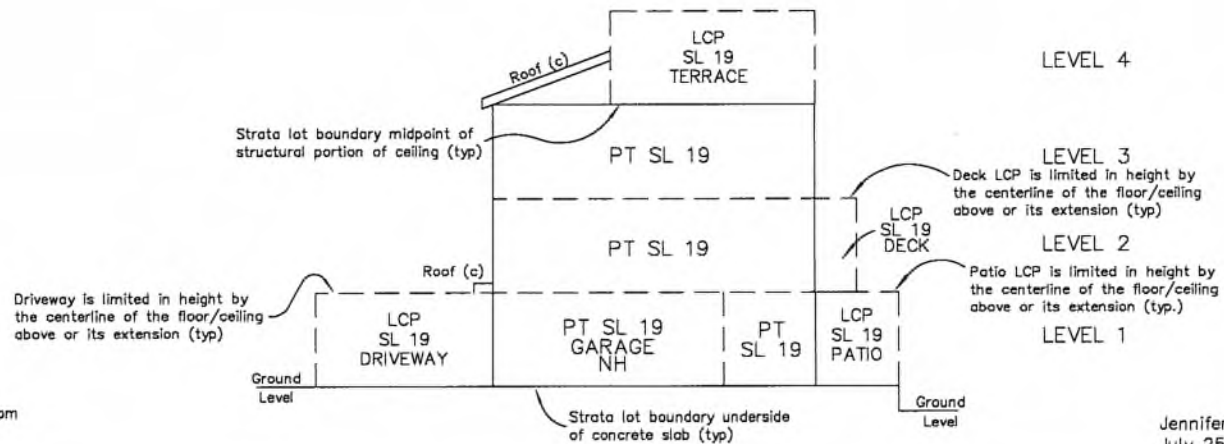

**RUNNALLS DENBY**

british columbia land surveyors

259A Lawrence Avenue  
Kelowna, B.C.  
V1Y 6L2

Phone: (250)763-7322  
Email: jen@runnallsdenby.com

# BUILDING 7 LEVEL 1

## STRATA PLAN EPS9966 PHASE 2



The intended plot size of this plan is 432mm in width by 280mm in height (B size) when plotted at a scale of 1:125  
(All distances are in metres)

- LEGEND**
- SL Denotes Strata Lot
  - NH Denotes Non-Habitable
  - LCP Denotes Limited Common Property
  - PT Denotes Part of Strata Lot

This sheet shows strata boundary dimensions to the midpoint of the structural portion of the exterior walls and the midpoint between structural portions of party walls between strata lots.

All LCP Patios, Decks, Driveways and Terraces are limited in height by the center of the floor above, or its extensions, or where there is no floor above, by the average height of a Strata Lot in the same building, unless otherwise indicated.

Cross section arrows on this plan point in the direction of view.

This sheet does not include any grid bearings, non-tangential deflections are noted as angles in degrees and minutes.

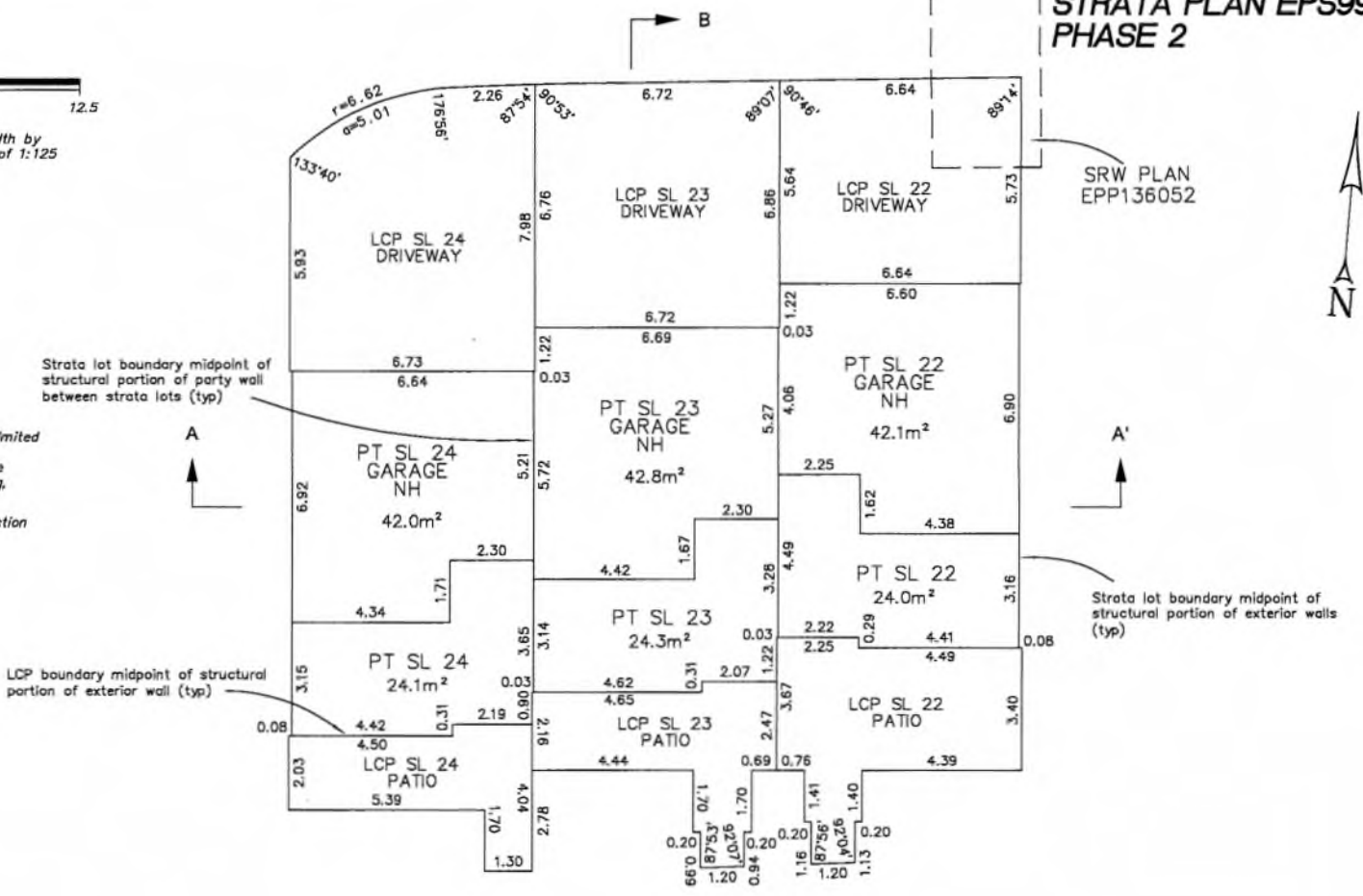

SRW PLAN  
EPP136052



Strata lot boundary midpoint of structural portion of party wall between strata lots (typ)

LCP boundary midpoint of structural portion of exterior wall (typ)

Strata lot boundary midpoint of structural portion of exterior walls (typ)

**RUNNALLS DENBY**

*british columbia land surveyors*

259A Lawrence Avenue  
Kelowna, B.C.  
V1Y 6L2

Phone: (250)763-7322  
Email: jen@runnallsdenby.com

DWG. No.: 16488 Strata FILE: 16488

Jennifer Ashton, BCLS 984  
July 25th, 2024

# BUILDING 7 LEVEL 2

## STRATA PLAN EPS9966 PHASE 2



The intended plot size of this plan is 432mm in width by 280mm in height (B size) when plotted at a scale of 1:125  
( All distances are in metres )

**LEGEND**

- SL Denotes Strata Lot
- LCP Denotes Limited Common Property
- PT Denotes Part of Strata Lot
- PFB Denotes Perimeter of Floor Below

This sheet shows strata boundary dimensions to the midpoint of the structural portion of the exterior walls and the midpoint between structural portions of party walls between strata lots.

All LCP Patios, Decks, Driveways and Terraces are limited in height by the center of the floor above, or its extensions, or where there is no floor above, by the average height of a Strata Lot in the same building, unless otherwise indicated.

Cross section arrows on this plan point in the direction of view.

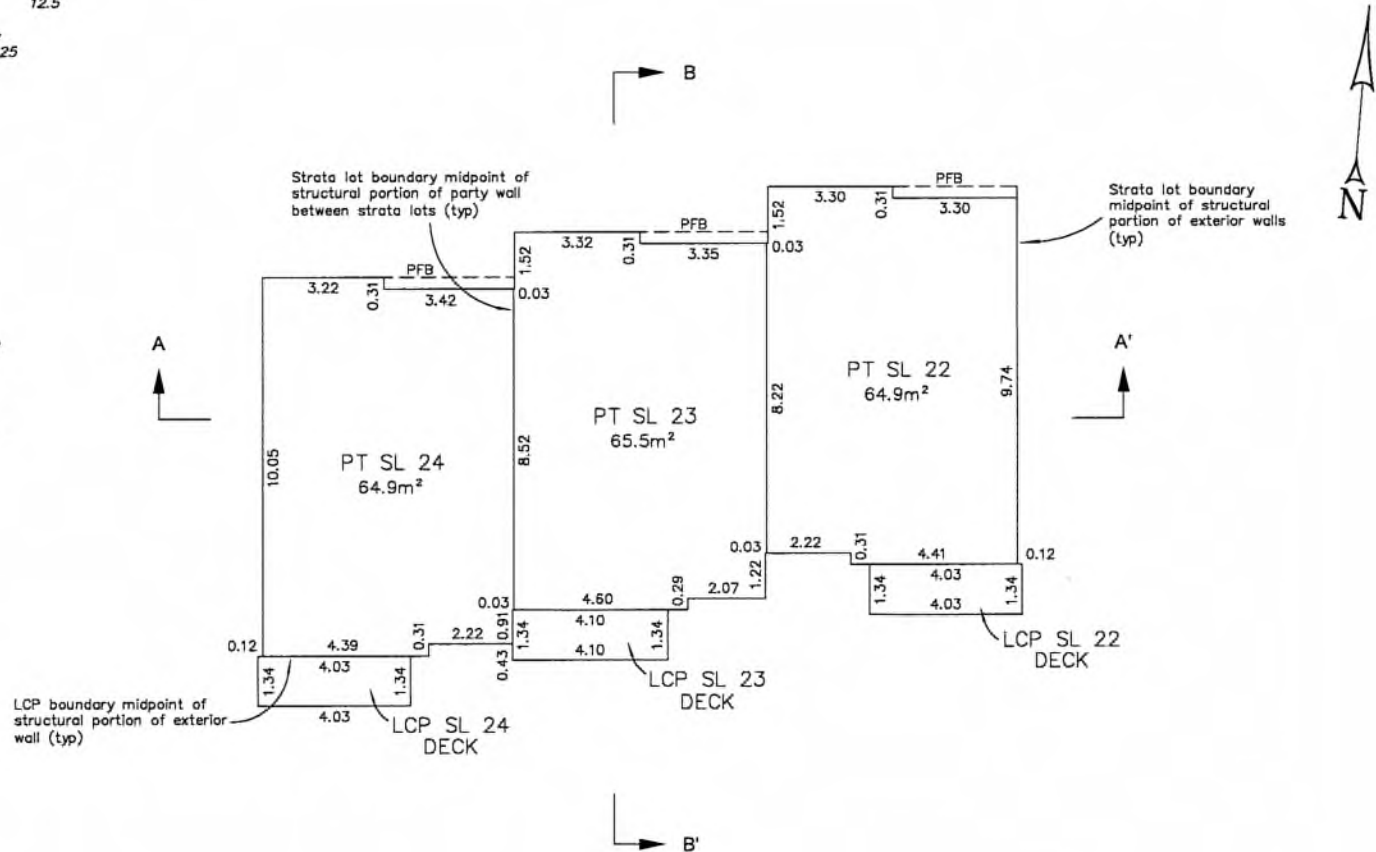

**RUNNALLS DENBY**

british columbia land surveyors

259A Lawrence Avenue Kelowna, B.C. V1Y 6L2  
Phone: (250)763-7322  
Email: jen@runnallsdenby.com

# BUILDING 7 LEVEL 3

Sheet 15 of 17 Sheets

## STRATA PLAN EPS9966 PHASE 2



The intended plot size of this plan is 432mm in width by 280mm in height (B size) when plotted at a scale of 1:125  
( All distances are in metres )

### LEGEND

- SL Denotes Strata Lot
- LCP Denotes Limited Common Property
- PT Denotes Part of Strata Lot

This sheet shows strata boundary dimensions to the midpoint of the structural portion of the exterior walls and the midpoint between structural portions of party walls between strata lots.

Cross section arrows on this plan point in the direction of view.

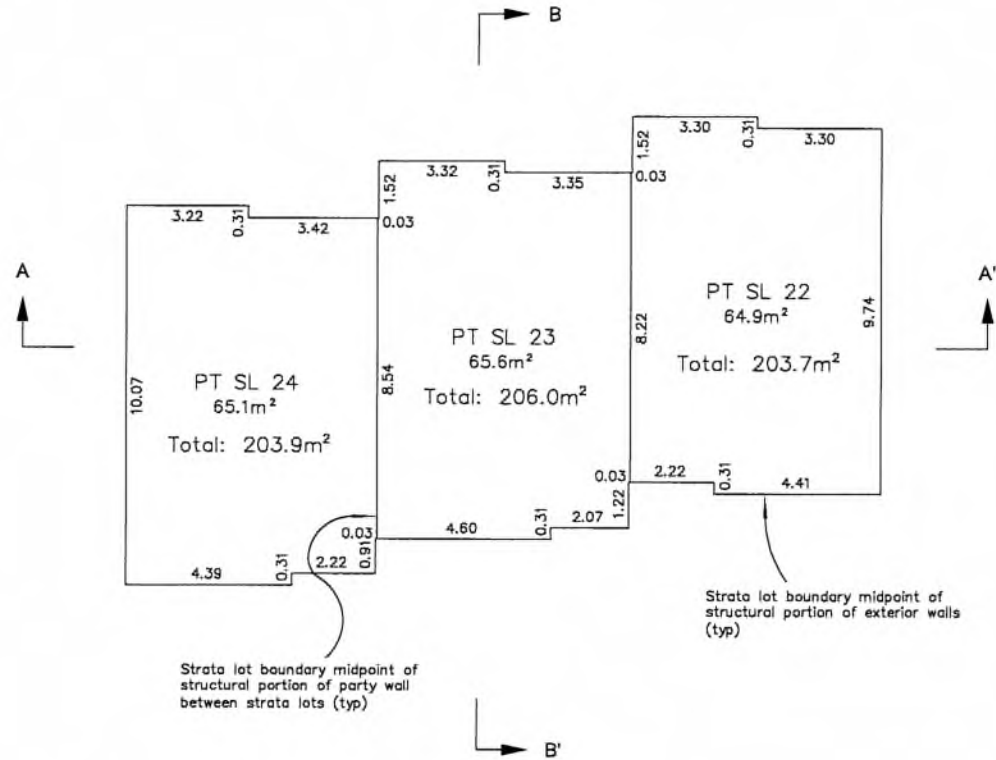

### RUNNALLS DENBY

british columbia land surveyors

259A Lawrence Avenue  
Kelowna, B.C.  
V1Y 6L2

Phone: (250)763-7322  
Email: jen@runnallsdenby.com

DWG. No.: 16488 Strata

FILE: 16488

Jennifer Ashton, BCLS 984  
July 25th, 2024



# BUILDING 7 LEVEL 4

## STRATA PLAN EPS9966 PHASE 2



The intended plot size of this plan is 432mm in width by 280mm in height (B size) when plotted at a scale of 1:125  
( All distances are in metres )

**LEGEND**

- SL Denotes Strata Lot
- LCP Denotes Limited Common Property
- PT Denotes Part of Strata Lot
- PFB Denotes Perimeter of Floor Below
- (c) Denotes common Property

This sheet shows strata boundary dimensions to the midpoint of the structural portion of the exterior walls and the midpoint between structural portions of party walls between strata lots.

All LCP Patios, Decks, Driveways and Terraces are limited in height by the center of the floor above, or its extensions, or where there is no floor above, by the average height of a Strata Lot in the same building, unless otherwise indicated.

Cross section arrows on this plan point in the direction of view.

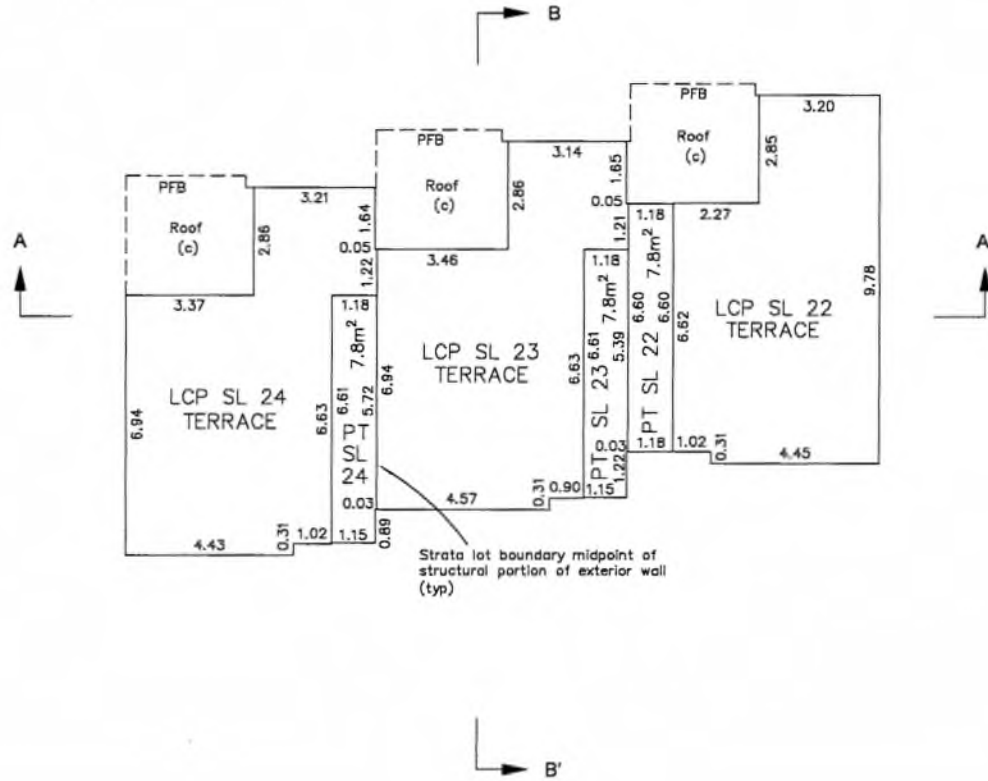

Strata lot boundary midpoint of structural portion of exterior wall (typ)

**RUNNALLS DENBY**

british columbia land surveyors

259A Lawrence Avenue Phone: (250)763-7322  
Kelowna, B.C. Email: jen@runnallsdenby.com  
V1Y 8L2

DWG. No.: 1648B Strata FILE: 16488

Jennifer Ashton, BCLS 984  
July 25th, 2024

# BUILDING 7 CROSS SECTIONS

## STRATA PLAN EPS9966 PHASE 2



The intended plot size of this plan is 432mm in width by 280mm in height (B size) when plotted at a scale of 1:150  
(All distances are in metres)

**LEGEND**

- SL Denotes Strata Lot
- LCP Denotes Limited Common Property
- PT Denotes Part of Strata Lot
- NH Denotes Non-Habitable

This sheet shows strata boundary dimensions to the midpoint of the structural portion of the exterior walls and the midpoint between structural portions of party walls between strata lots.

All LCP Patios, Decks, Driveways and Terraces are limited in height by the center of the floor above, or its extensions, or where there is no floor above, by the average height of a Strata Lot in the same building, unless otherwise indicated.

CROSS SECTION A-A'

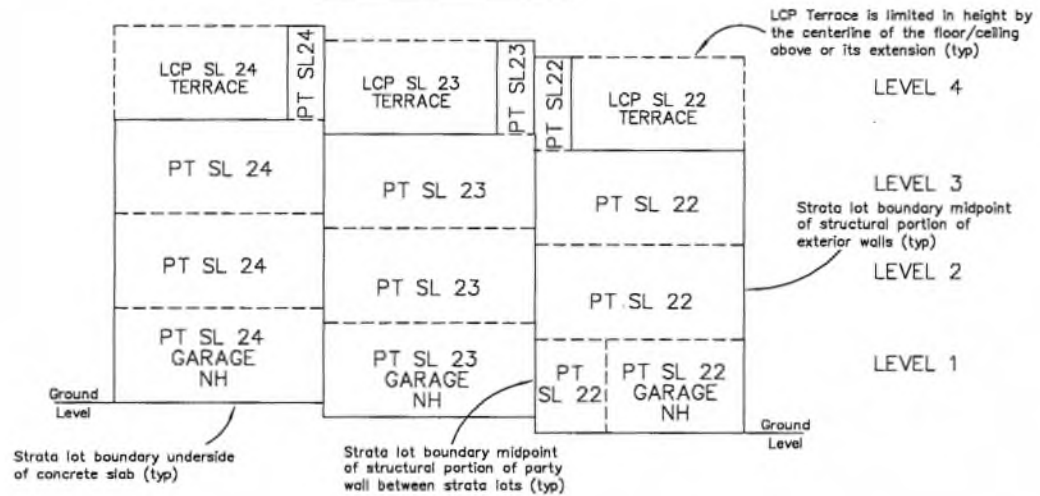

CROSS SECTION B-B'

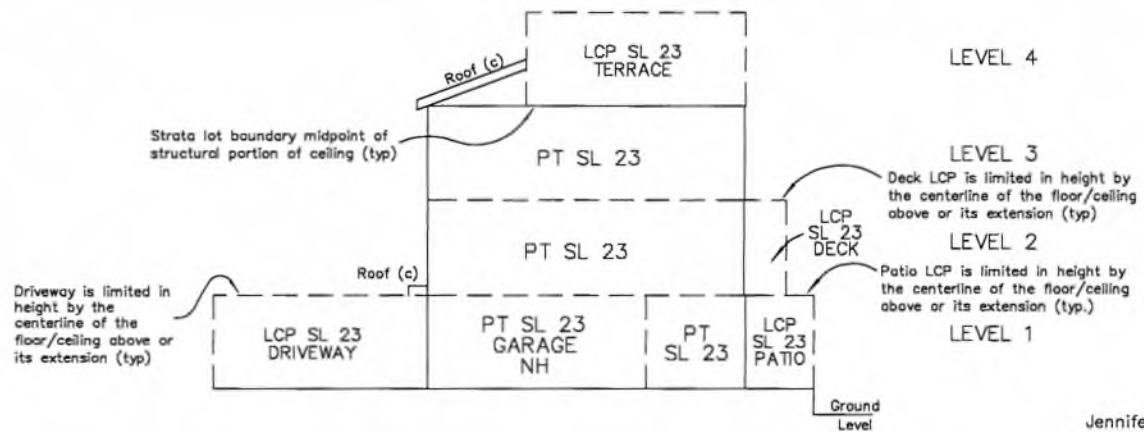

**RUNNALLS DENBY**

british columbia land surveyors

259A Lawrence Avenue  
Kelowna, B.C.  
V1Y 6L2

Phone: (250)763-7322  
Email: jen@runnallsdenby.com

DWG. No.: 16488 Strata

FILE: 16488

Jennifer Ashton, BCLS 984  
July 25th, 2024